

## SOLINVED 12,8/25,6/51,2 LİTYUM BATARYALAR KURULUM

### SOL 12,8/25,6V BAĞLANTISI

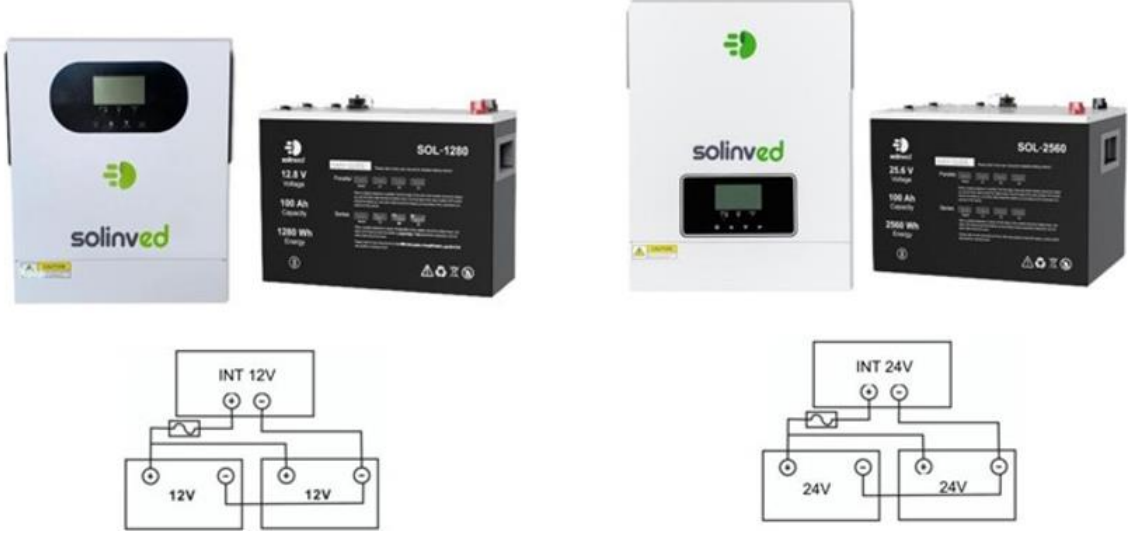

### SOL Serisi Akü Seri ve Paralel Yönlendirme

- 1- Aynı sistemde farklı akü tipleri kullanılamaz.
- 2- Aküler seri veya paralel olarak bağlanmadan önce her bir akü tam olarak şarj edilmiş olmalıdır ve aküler arası voltaj farkı 100mV içinde olmalıdır.
- 3- Akü kesme voltajının altında olduğunda, BMS kapatma koruması gerçekleşecektir.
- 4- Seri veya paralel olarak kullanılan akü sisteminin maksimum akımı 100A'dır.
- 5- Aküler seri veya paralel bağlandığında, yükün pozitif kısmına bağlı olan akü master, negatif kısmına bağlı olan aküler slave olarak kullanılır.
- 6- 12/24V aküler için maksimum 48V olacak şekilde seri bağlanabilir.
- 7- Aynı sistemde kullanılacak bataryalar arasında voltaj farkı var ise, balans ayarı yapılmalıdır.

### 12,8/25,6V AKTİF BALANS/ TEK BATARYA AYARLARI

#### AKTİF BALANS

Aktif Balans modunu kullanmanın öncülü:



1. Seri veya paralel bağlantıdan önce sistemdeki her batarya arasındaki voltaj farkı  $>0,3V$  ise









Batarya voltaj farkını dengelemek için bataryaları paralel bağlayın, İnvertöre bağlamanıza gerek yoktur. Switchleri şekildeki gibi ayarlayın. Bataryaları slave olandan başlayarak açın ve aktif balansı başlatın.









#### TEK BATARYA



Tek batarya kullanılacaksa batarya switchlerinin şekildeki gibi olduğundan emin olun. Switchler fabrika çıkışlı olarak bu şekilde ayarlanmıştır.

## 12,8/25,6V SERİ / PARALEL BAĞLANTI SWITCH AYARLARI

Parallel dialing			
BatteryQty	2pcs	3pcs	4pcs
Master			
S1			
S2			
S3			

Series dialing			
BatteryQty	2pcs	3pcs	4pcs
Master			
S1			
S2			
S3			

## 12V SİSTEM OFF GRID HİBRİT İNVERTER BATARYA AYARLARI



05 Battery Type	02 Max Charging current	26 Bulk Charge Voltage	27 Float Charge Voltage	28 Low cut off voltage
USE	50A Per battery MAX	14.2V	13.8V	12V

## 24V SİSTEM OFF GRID HİBRİT İNVERTER BATARYA AYARLARI



USE	50A Per battery MAX	28.4V	27.6V	24V
-----	------------------------	-------	-------	-----

Bataryayı kullanırken, iletişim kablosunu (485) bağlamanız ve DIP anahtarını ayarlamanız gerekir.

## SOL 12,8V LİTYUM BATARYA TEKNİK VERİLERİ

Model	SOL-1280
Nominal Voltage	12.8V
Nominal Capacity @1C	100Ah
Charge Voltage	14.8V
Charge Current Max Continuous	50A
Discharge Current Max Continuous	100A
Discharge Voltage Minimum	10.4V
Pulse Current 5 Sec	125A
Weight	13.4kgs±0.5kgs
Dimensions L*W*H	360*140*250 mm
IP Rating	IP65
Calendar Life & Performance Guarantee [1]	3500 cycles or 5 years, whichever comes first
Operating Temperature	Charging: 0°C to 45°C
	Discharging: -10°C to 55°C
Storage Temperature	-10~35°C
Relative Humidity (R H)	0% ~ 95% (No Condensed Water)
Safety Certificate	CE( IEC 62040 ), MSDS
Transportation Certificate	UN3480

## SOL 25,6V LİTYUM BATARYA TEKNİK VERİLERİ

Model	SOL-2560
Nominal Voltage	25.6V
Nominal Capacity @1C	100Ah
Charge Voltage	29.2V
Charge Current Max Continuous	50A
Discharge Current Max Continuous	100A
Discharge Voltage Minimum	20.8V
Pulse Current 5 Sec	125A
Weight	22.9kgs±0.5kgs
Dimensions L*W*H	360*260*250 mm
IP Rating	IP65
Calendar Life & Performance Guarantee [1]	3500 cycles or 5 years, whichever comes first
Operating Temperature	Charging: 0°C to 45°C
	Discharging: -10°C to 55°C
Storage Temperature	-10~35°C
Relative Humidity (R H)	0% ~ 95% (No Condensed Water)
Safety Certificate	CE( IEC 62040 ), MSDS
Transportation Certificate	UN3480

## SOLINVED 51.2 LİTYUM BATARYA KURULUM

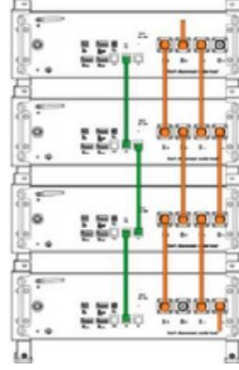

(Paralel Bağlantı)

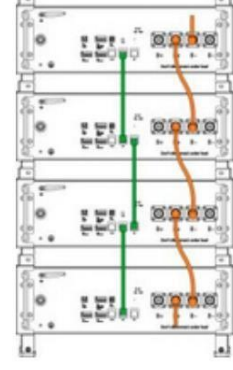

(Seri Bağlantı)

## 48V SİSTEM OFF GRID HİBRİT İNVERTER BATARYA AYARLARI

05 Battery Type	02 Max Charging current	26 Bulk Charge Voltage	27 Float Charge Voltage	28 Cut Off Voltage
USE	60A	54.6V	54.2V	48V

## SOLINVED 51,2 LİTYUM BATARYA SWITCH AYARLARI

### SWITCH AYARLARI

- CAN protokolü ile haberleşme için SW1 1 ve 2.pin yukarda olmalı, RS485 haberleşme protokolü için SW1 3 ve 4.pin yukarda olmalıdır.
- Solinved Infini (RS485) invertörler ile haberleşme için SW4(RS485B) 3.pin yukarda olmalı, SW5(485A) 5.pin yukarda olmalıdır. Bağlı akülerin hepsinde SW4 ve SW5 bu şekilde ayarlanır.
- Solinved(RS485) invertörler ile haberleşme için SW4(RS485B) 6.pin yukarda olmalı, SW5(485A) 5.pin yukarda olmalıdır. Bağlı akülerin hepsinde SW4 ve SW5 bu şekilde ayarlanır.
- Deye(CAN) invertörler ile haberleşme için SW4(CANL) 5.pin yukarda olmalı, SW5(CANH) 4. Pin yukarda olmalıdır. Bağlı akülerin hepsinde SW4 ve SW5 bu şekilde ayarlanır.
- Solis(CAN) invertörler ile haberleşme için SW4(CANL) 5.pin yukarda olmalı, SW5(CANH) 4. Pin yukarda olmalıdır. Bağlı akülerin hepsinde SW4 ve SW5 bu şekilde ayarlanır.

○ ○  
Run Fault



SW1  
1-2 CAN  
3-4 485

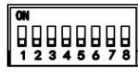

SW2  
1(120R\_M/S)  
3(120R\_INV)  
8(Serial)



SW3  
Address



Reset



Run

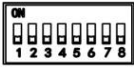

SW4  
CANL/485B

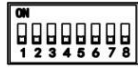

SW5  
CANH/485A

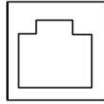

Inverter

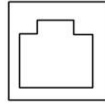



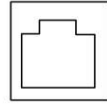



























































M/S



M/S

Battery QTY	M/S	SW2 Setting		SW3 Setting			
		Series connection	Parallel connection				
1	—		13		13		1
2	Master		138		13		2
	Slave		18		1		1
3	Master		138		13		3
	Slave 1		8		0		1
	Slave 2		18		1		2
4	Master		138		13		4
	Slave 1		8		0		1
	Slave 2		8		0		2
	Slave 3		18		1		3
5	Master		138		13		5
	Slave 1		8		0		1
	Slave 2		8		0		2
	Slave 3		8		0		3
	Slave 4		18		1		4

6	Master	 138	 13	 6
	Slave 1	 8	 0	 1
	Slave 2	 8	 0	 2
	Slave 3	 8	 0	 3
	Slave 4	 8	 0	 4
	Slave 5	 18	 1	 5
7	Master	 138	 13	 7
	Slave 1	 8	 0	 1
	Slave 2	 8	 0	 2
	Slave 3	 8	 0	 3
	Slave 4	 8	 0	 4
	Slave 5	 8	 0	 5
	Slave 6	 18	 1	 6
8	Master	 138	 13	 8
	Slave 1	 8	 0	 1
	Slave 2	 8	 0	 2
	Slave 3	 8	 0	 3
	Slave 4	 8	 0	 4
	Slave 5	 8	 0	 5
	Slave 6	 8	 0	 6
	Slave 7	 18	 1	 7

## SMART ENERGY PLAT KURULUM

- Google Play Store/App Store üzerinden Smart Energy Plat uygulamasını indirin.
- Uygulamayı açın, “Click Create a New Account” a tıklayarak hesap oluşturun.

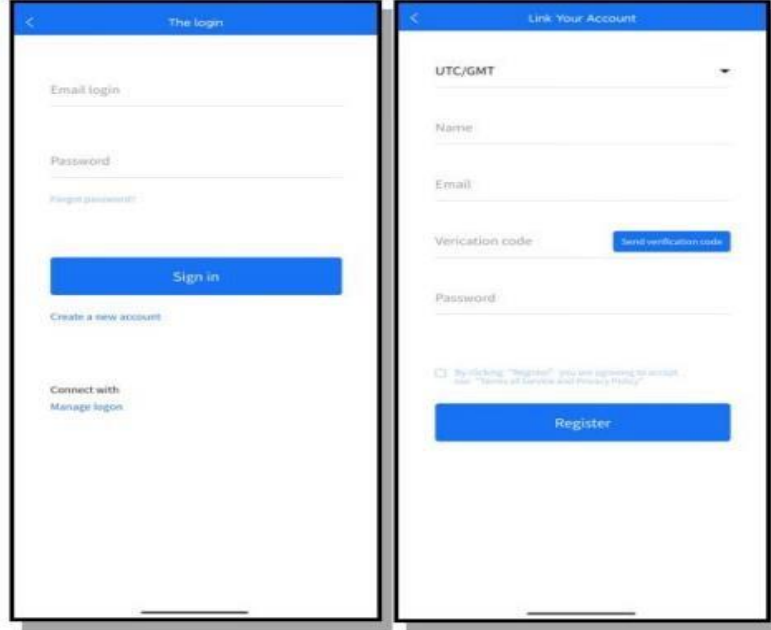

- “Add batteries” seçeneğine tıklayın.
- Batarya üzerindeki kodu tarafın veya manuel olarak bataryanın seri numarasını yazın.

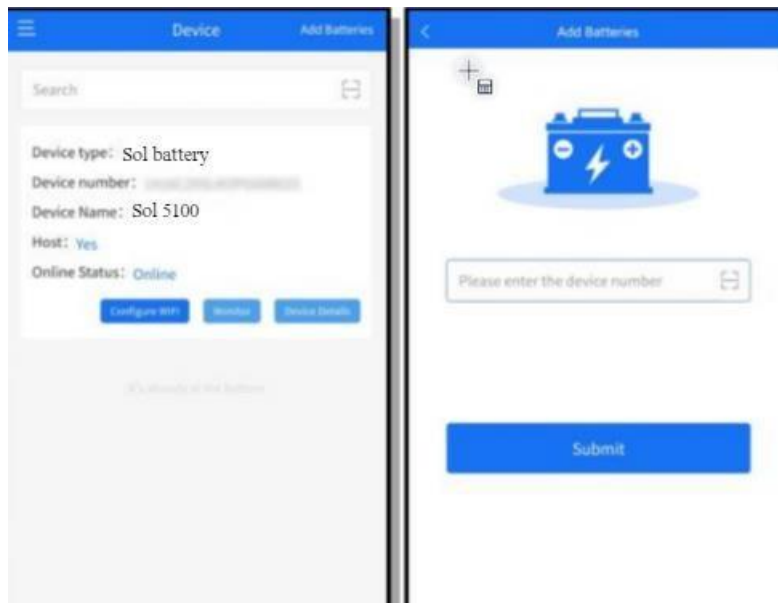

- Batarya listesinden “Configure WiFi” seçeneğine tıklayın.
- Kullandığınız internete bağlanın veya manuel olarak WiFi adını ve şifreyi yazın.

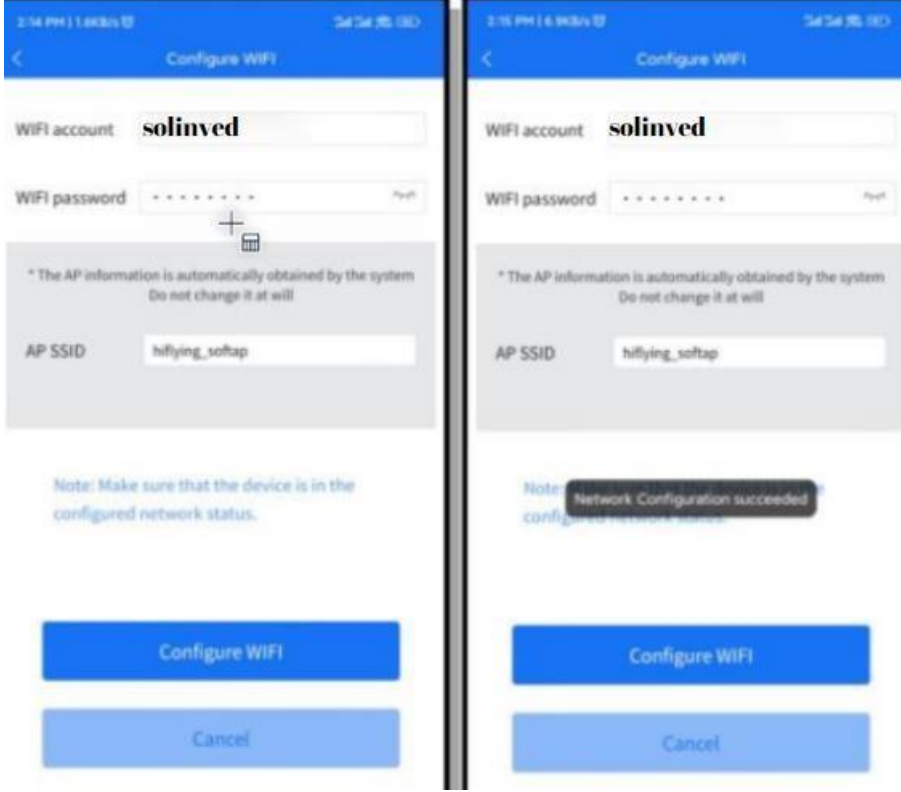

- WiFi'ye bağlanın.
- “Run” ışığı hızla yanıp sönene kadar batarya üzerindeki “reset” butonuna 3 saniye basın.

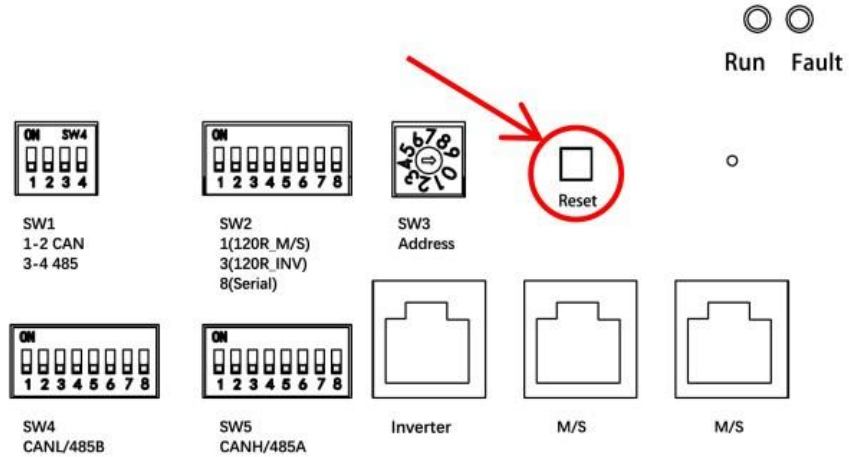

- Uygulama üzerinden “Configure Wifi” seçeneğine tıklayın.
- Wifi konfigürasyonu bir dakika içerisinde otomatik olarak başlayacak ve tamamlanacaktır.